

MiJia Heating Pressure Rice Cooker

Before using the device, read the instructions carefully

Content

YLIH01CM_V2.0

Please read the instructions carefully to ensure correct and safe use of this device.

This product is only intended for home use.

Pay special attention to the section «Precautions» (p. 8-9)

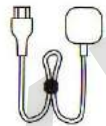

Power cable

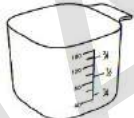

Measuring cup



Spoon (flat)



Ложка (soup)

Before use

1. Introduction to the product	02
2. Fast using	03
3. The client application App	03
4. Regulation of the time in standby mode	04

Usage

5. Operation Manual	04
Cooking, quick cooking	05
Rice porridge, heat preservation	05
Personal settings, the choice of the program	05
6. Cleaning the rice cooker	
The assembly, disassembly	06

FAQ

7. Troubleshooting	05
8. Fault codes	07
9. Precautions	07
10. Basic settings	08
11. Name of Product	08
12. The presence of toxic and hazardous substances	08
13. Schematic diagram	09
14. Warranty	09

Introduction to the product

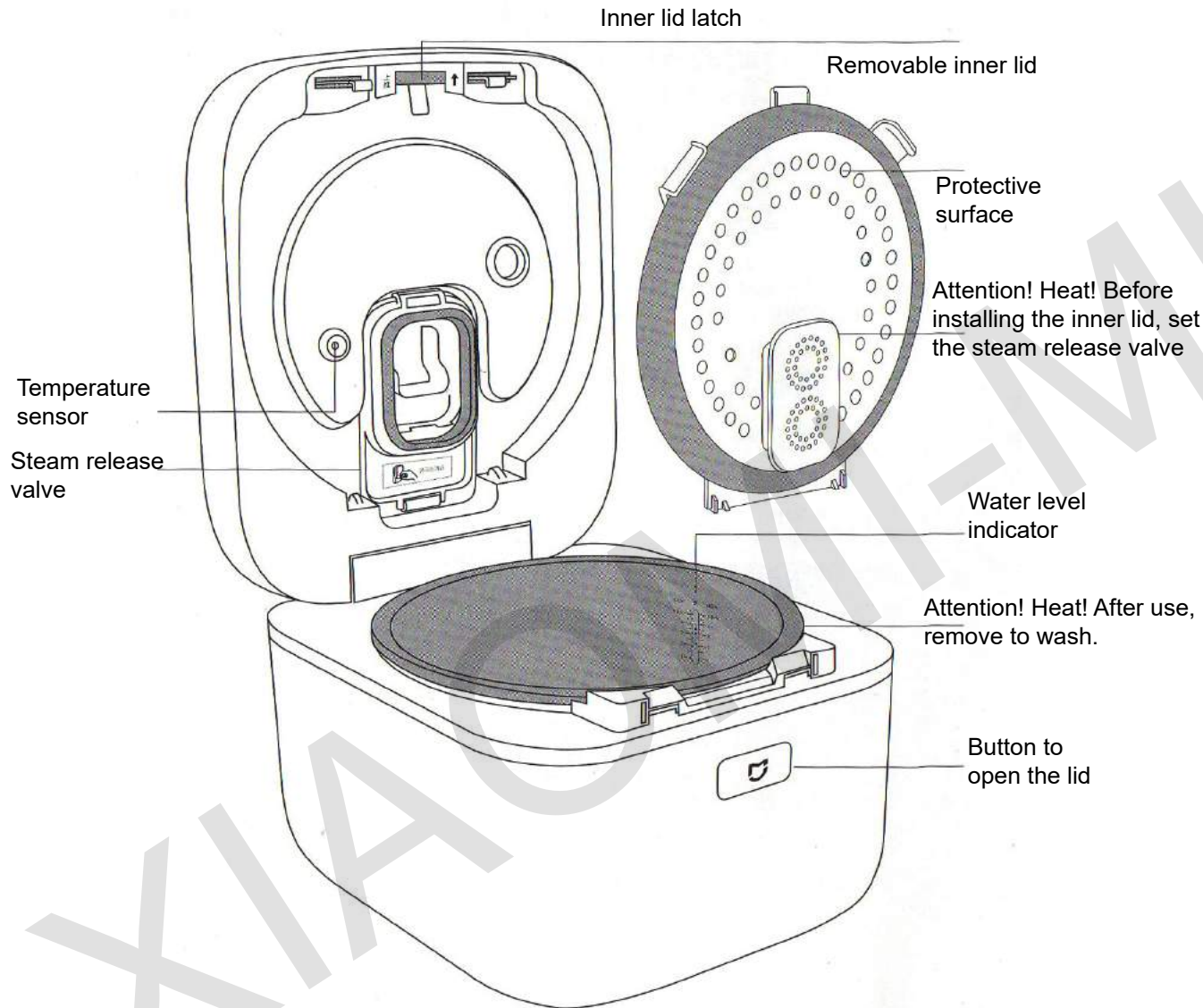

The back side of inner cover

The front side of inner cover

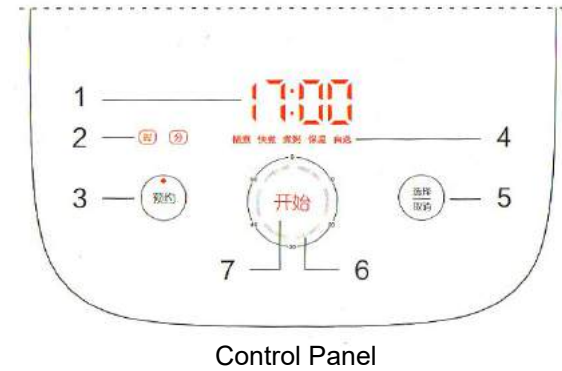
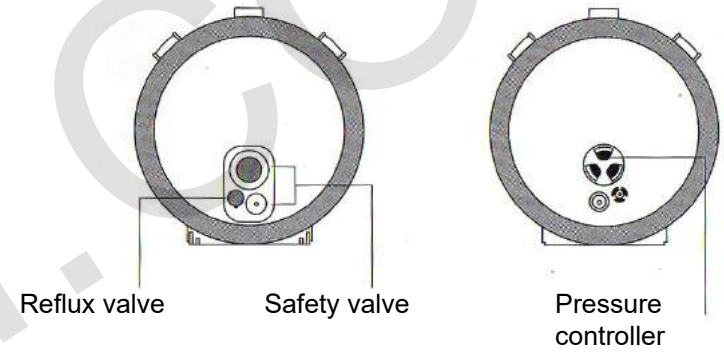

1. LED digital display time
2. Time control buttons (hours / minutes)
3. Select of program
4. Menu
5. Select / Cancel
6. Digital timer
7. Start Button

Quick using

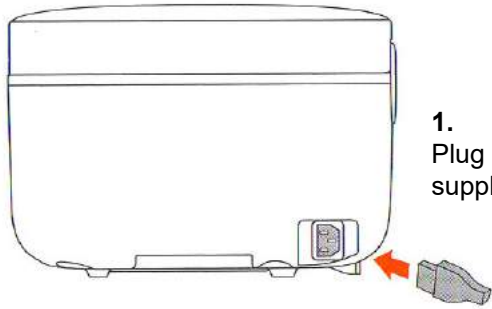

1. Power Connection

Plug one end into the rice cooker, and the second - to a power supply.

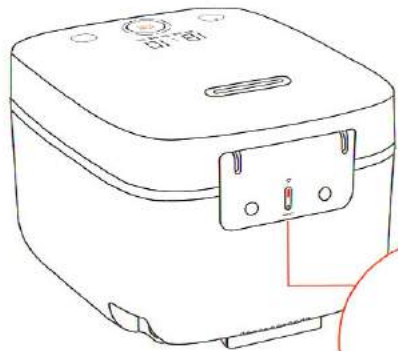

2. Wi-Fi connection

Connecting Rice cooker to the power supply for the first time will automatically open connection to network. Connect the new device in the application «Mi Smart Home».

Note: Use a thin object to press and hold for 5 seconds the reset button Wi-Fi, and then re-open standby connection to the network.

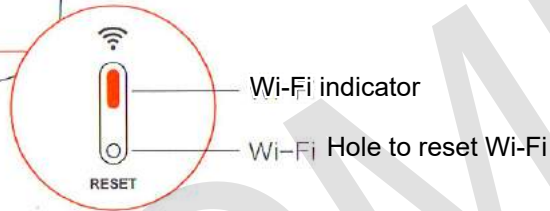

Wi-Fi indicator

Wi-Fi Hole to reset Wi-Fi

Wi-Fi Indicator

Waiting for connection	Connecting to a network	Connecting successfully
Yellow blinks	Blue blinks	Blue lit

Application

Even more Smart devices can be found in a mobile application Mi «Smart Home»

Installing the client application

To install the client application on your smartphone, open Mi Store and search for «Mi Smart Home» App or scan the QR-Code.



This device is already in the list of devices in the «Mi Smart Home», supporting MIUI system, and can interface with other intelligent devices of your home.

By connecting a smartphone to the Wi-Fi network, open the downloaded client application and follow the instructions shown on the phone display.

Regulation of time in standby mode

Press and hold program selecting button for 5 seconds to enter the time control mode.

Warning: when you connect to the Internet, the time will be automatically tuned.

1. Press and hold for 5 seconds

Cooking / Fast cooking / Rice porridge / Heat preservation / Personal settings



Cooking / Fast cooking / Rice porridge / Heat preservation / Personal settings

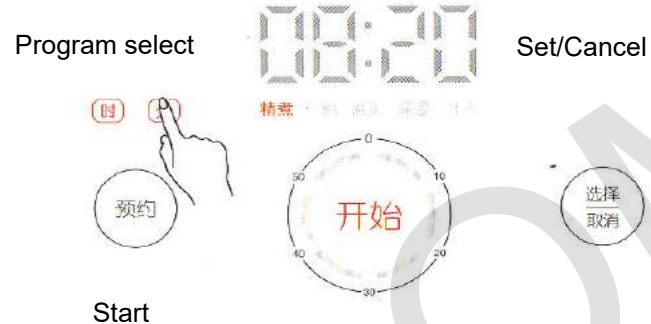

2. To adjust the time, use the «Hour» and «Minute» buttons, and then click on the «Start» button to confirm your selection.

Switching menu

Click on «Select / Cancel» to select a desired mode. Each time you press the button, mode will be switched in turn: «Cooking / Quick cooking / Rice porridge / Heat preservation / Personal settings»

Set/Cancel



1. Cooking

Turn on «Cooking» mode. The program will automatically configure the cooking duration depends on the amount of rice (the default time of cooking - 1 hour).



Cooking / Fast cooking / Rice porridge / Heat preservation / Personal settings

2. Quick cooking

Automatic detection of the cooking time depending on the amount of rice (default cooking time - 40 minutes).



Cooking / Fast cooking / Rice porridge / Heat preservation / Personal settings

3. Rice porridge

Time default cooking - 1.30. Adjust porridge cooking time.

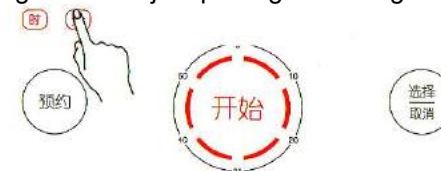

Cooking / Fast cooking / Rice porridge / Heat preservation / Personal settings

Set the desired cooking time by pressing the «Hour» and «Minute» buttons. Control range - from 40 minutes to 4 hours.

Switching menu

4. Heat preservation

At the end of cooking, the rice cooker automatically switches to the keep warm mode. Maintain temperature is about 73 C.

You can manually select the mode of keeping warm.

Warning: not recommended to leave heat preservation mode switched on for more than 12 hours. If this mode is activated for more than 24 hours, the rice cooker automatically switches to standby mode (heat preservation mode is turned off).



Cooking / Fast cooking / Rice porridge / Heat preservation / Personal settings

5. Personal settings

The app recommends a creation of a plurality of modes of different delicious dishes. Use the App to run your own settings for the preparation of meals.



Cooking / Fast cooking / Rice porridge / Heat preservation / Personal settings

6. Program select

1. After selecting the desired mode (eg «Cooking»), click on the «Select program» to make the settings.



Note: When selecting a program, make sure to set the correct current time on the rice cooker.

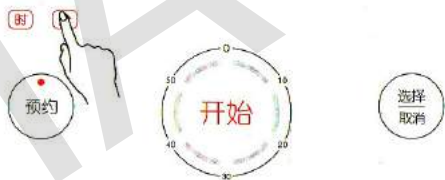

2. Set the cooking time by pressing the buttons «Hour» and «Minute», and then click on the «Start» button to start cooking.

Note: Set the time in 24 hour format.

Trouble-shooting

Type of failure	Diagnosing faults and correct them
Unable to close the lid	Check the settings of inside cover
The lack of response buttons	Probably the rice cooker is in Ready mode. Select a program mode or Heat preservation mode. Click "Cancel" to exit cooking
Leakage of steam during cooking	Leakage is possible due to the aging of silicone sealing parts, deformities or damage
Half-baked dish	Improper ratio of water and rice (too little water)
	The date of production of rice more than 6 months
	The presence of foreign objects on the surface of the bottom of the bowl or sensor
Overflow rice cooker when cooking rice porridge	The deformation of the outer surface of the cup
	Deformation of the bottom surface bowl
	Improper ratio of water and rice (too much water / rice)
Parted boiled rice as result of cooking	The presence of foreign objects on the surface of the bottom of the bowl or sensor
	The deformation of the outer surface of the cup
	Included saving mode heat more than 12 hours
Strange odors during cooking	The presence of food residue on the inside of the cover after previous preparation or water retention
	The presence of peculiar smell of steam valve and inner lid sealing gasket
Dark color of food on the bottom	It should be completely washed rice
	The presence of foreign objects on the bottom surface of the removable inner pot or sensor
	The deformation of the outer surface of the cup
	The deformation of the pan bottom surface
Hardening food in Heat preservation mode or smell appearance	Included saving mode heat more than 12 hours
	The presence of foreign objects on the surface of the bottom of the bowl or sensor
	The deformation of the outer surface of the cup
Problems with the operation of program selection	Deformation of the bottom surface bowl
	Cycle time of select the program from the current to the end of cooking is shorter than for cooking
	After installation time select the program did not click on the "Start"
The lack of connection to Wi-Fi	Check the stability or Wi-Fi signal when setting up the program of choice for smartphone
	Check you have the latest version of the APP
Update problems	Make sure the rice cooker relatively close placement of the Wi-Fi signal. Make sure there is enough strong signal
	Perhaps the rice cooker to be in preparation mode
The device is frozen after firmware update	Problems with Wi-Fi signal
	After a power failure, click to select the program to re-supply the power. You can return the factory setting

Cleaning of the Rice cooker

1. Disassembling

1. Turn left to remove a protective cover

Note: After each use it is necessary to wash the inner cover and steam release valve.



2. After a light pressing on a latch inside of cover, it automatically pops up. Remove the inner cover.

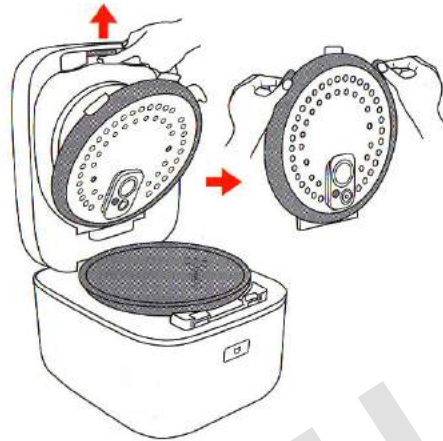

3. Under inner cover, you will see the steam release valve, which must be removed.

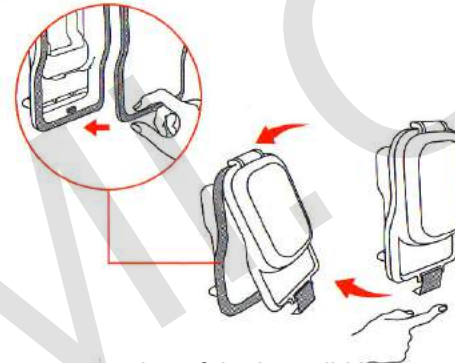

Open a latch, pull the gasket. Open a steam release valve, pull the latch to the side, open the valve, and then remove the seal.



2. Assembling

1. Install the gasket, align, close up.



1. Hold the gasket in its groove, align it, and then lightly press down on the latch until you hear a «click».

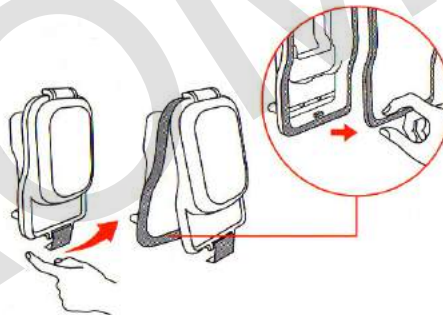

3. Insert a support ring of the inner lid in a special slot in the rice cooker, slightly press down an inner cover up until you hear a «click».

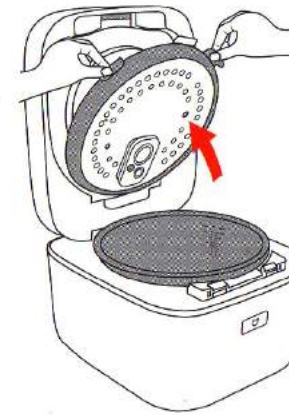

4. Insert a protective surface along the fixing plate on a right side.

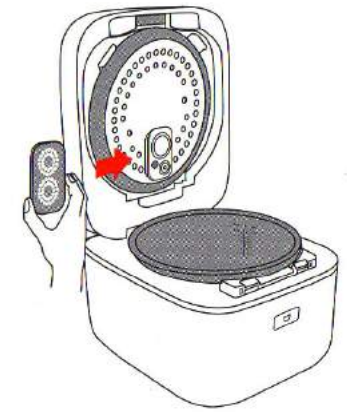

2. Accurately move the pair of release valve on the steam outlet hole, and then lightly pressing down, slowly insert it into the installation location.

Note: Steam release valve and the inner cover must be set differently or Rice cooker cover will not close properly.

Fault codes

LED Indication error: White LED indicates an error, the other indicators are off

E-01	If during cooking the lid open too long, rice cooker switches to standby
E-02	Empty bowl (no food in the bowl)
E-03	Protection against pressure 265V + 7V
E-04	Protection against low pressure 265V + 7V
E-05	Notification of the high temperature of the lower surface
E-06	Notification of the high temperature of the upper surface
E-07	High temperatures IGBT transistor
E-08	Damage SENSOR IGBT transistor (including electric shock or circuit break)
E-09	Damage to the sensor located at the top (including electric shock or circuit break)
E-10	Damage to the sensor located at the bottom (including electric shock or circuit break)
E-11	Sending the wrong or incorrect information

Precautions

Limitations of use:

For the normal functioning of the product height above sea level should be between 0 m - 2000 m.

Please do not install this product near the other sensitive to electromagnetic interference devices.

Please do not use foreign domestic cup or bowl with deformations, in order to avoid overheating, so that you can get injured or burned.

Care and Cleaning:

Do not immerse the product in water and do not spray the water to it.

Do not use hard sponge or other hard objects to wash rice cookers or bowl.

To clean the rice cooker with a soft cloth.

Power cable:

Use only the power cord that was originally supplied with the rice cooker.

Before performing any action on the maintenance of the device or moving, unplug the power cord from the wall outlet.

If the power cable is damaged, replace it with the same original power cable.

Do not twist, bend or peredavlivayte power cord. Otherwise, the current-carrying cable conductors are stripped or broken.

Do not use the rice cooker power cord for any other devices.

Safety in the operation of a power supply:

The excess of 220V AC, the use of the device is prohibited to prevent a fire.

It is strongly recommended to disconnect a power cord from the wall outlet to avoid electrical shock, short-circuit and ignite. To disconnect a power cord, do not use a lot of force.

Do not allow yourself to use the device to adolescents, set rice cooker out of reach of small children to avoid electric shock, scalding and occurrence of other accidents.

Do not insert or unplug a power cord with wet hands to avoid electric shock or other risks.

Do not use any foreign power cables.

Do not connect a power cord to the rice cookers block outlet to avoid a fire hazard.

Environment:

Due to the presence of steam and hot air emanating from the rice cooker, your walls and furniture can get damaged, change color or become deformed. To avoid such situations, while using the device set the rice cooker at a distance of 30 cm from walls and furniture.

In the case of installation rice cookers in the kitchen cupboard, or in other places, make sure there is ventilation when using the device.

Using:

While cooking is strictly forbidden to open the lid. After the rice cooker automatically finish cooking or pauses in the middle of the cooking process, wait for the full release of pressure, only open the device.

Do not install the inner bowl to other sources of heat to heat it up (eg, induction cooker, gas stove).

Do not insert any objects into the outlet or into other slots.

In the process of using of the rice cooker or immediately after cooking, be careful, don't be close to the hot steam. Especially watch out for children at the moment, to avoid burns.

In no case do not cook in the rice cooker products that can clog the exhaust port (eg, dried seaweed, seaweed and other leaf products).

It is strictly forbidden to put any objects on the rice cooker in the cooking process, as this may

lead to the blocking of the release of steam.

If the save temperature of any food longer than the time that is characteristic for normal cooking, you may see the peculiar smell of rice.

Completion of cooking:

After cooking, do not forget to turn off the rice cooker and disconnect it from the power supply.

Regularly check the steam release channel pair to make sure they are not clogged.

When a problem occurs, immediately discontinue use of the device, disconnect it from the power supply. Wait for rice cooker cooling, and then open the lid and remove the bowl.

Other special instructions:

Please, do not let fall or stress of the device to avoid breakage or any damage.

Do not use the rice cooker bowl, if it is damaged, to avoid burns or injury to hot steam, which can be released no control over other openings.

Do not remodel the unit. It is forbidden to perform maintenance, dismantle unauthorized device professionals to avoid the risk of fire, electric shock or other risks.

When a problem occurs, immediately discontinue use of the device, to avoid the risk of fire, electric shock or other risks.

Faults:

Overheating of power cord socket in the cooking process.

Seepage incomprehensible smoke / steam or burnt odor.

Availability split some parts of rice cookers, they are slacking or the presence of incomprehensible noise.

The deformation of the cup.

As well as other faults.

Main specifications

Name: Pressure IH Rice Cooker;

Model: YLIH01CM;

Capacity: 3.0L;

Heating method: IH heating;

Power Rating: 1100W;

Voltage / Rated Frequency: 220V - 50Hz;

Nominal working pressure: 20kPa;

Dimensions: 300 x 251 x 212 mm;

Wireless connectivity: Wi-Fi IEEE 802.11 b / g / n 2.4GHz;

Certificate number for this model: CMIIT ID: 2014DR5056 module.

Name of product

YLIH01CM

YLIH - short description of the functional characteristics.

01 - serial number of the construction.

CM - manufacturer.

Presence of toxic and hazardous substances

Name	Pb PBB	Hg PBDE	Cd PBDE	Cr6+
Exterior design	0	0	0	0
Internal components	0	0	0	0
Electrical components	X	0	0	0
Accessories	0	0	0	0

0: toxic and harmful substances in all components of the device are contained in an amount below the limit value according to SJ / T11363-2006 «limit the requirement for toxic and hazardous substances in products.»

X: indicates the presence of toxic and harmful substances, at least one of the components of this product in excess of the limit value, according to SJ / T11363-2006 «Requirements limiting the presence of toxic and hazardous substances in products.»

Schematic diagram

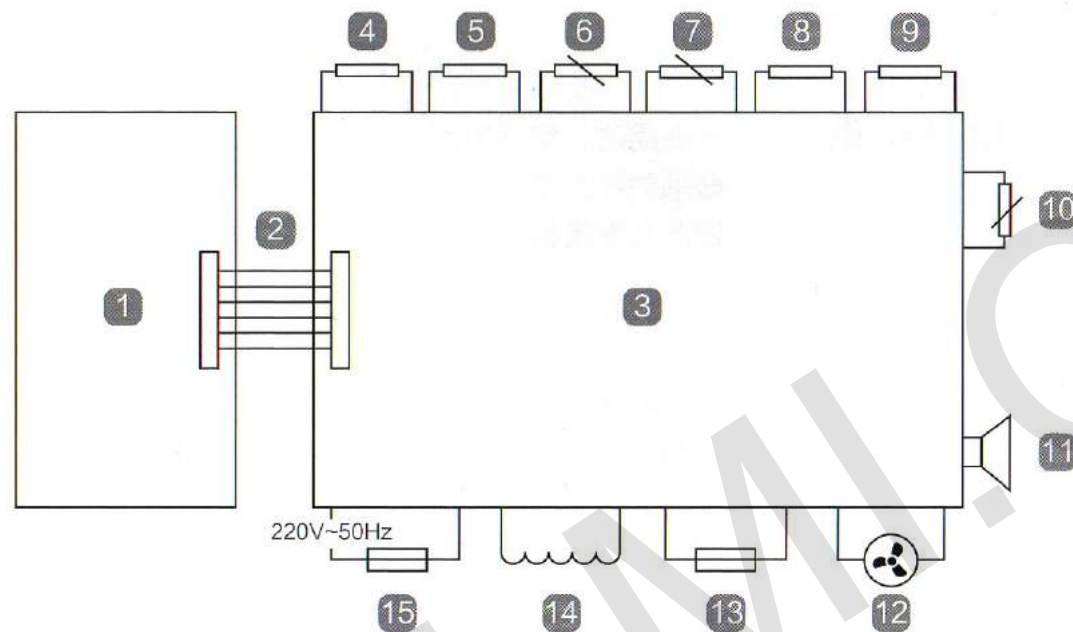

1. The main control circuit board
2. Connection cable
3. Power panel (switchboard)
4. The side walls of the heating unit
5. The upper surface of the heating unit
6. Temperature Sensor bottom surface
7. The upper surface of the temperature sensor
8. The solenoid valve
9. Hall Sensor
10. Temperature sensor IGBT
11. Speaker
12. Fan
13. Temperature fuse
14. The electromagnetic coil (solenoid)
15. The fuse of electric current

Warranty

Warranty service is carried out in accordance with the law on «consumer rights» and the «Law on the quality of products.»

The warranty service includes:

1. Within 7 days of purchase and signing the warranty card, in the event of a problem, if its cause is not the human factor, after the presentation of the current guarantees and other documents, the buyer can choose a free replacement product, return or repair.

2. When returning goods purchased on the official Xaiomi website or through other official Xaiomi representation, without any justification, within 7 days after purchase, all shipping costs assumes the consumer (when returning the purchase payment for travel costs not

returns). At the same time return the goods within 7 days after the purchase is not possible in the following cases: the goods for damage incurred due to the human factor, missing or damaged packaging, or any component.

3. Within 15 days from the date of purchase and signing the warranty card, in the event of a problem, if its cause is not the human factor, the buyer can choose a free replacement or repair of the goods (free samples of goods can not be exchanged).

I Warranty terms

Note: In the process of transportation of goods is necessary to ensure its integrity and security. Therefore, we recommend that you retain the packaging for at least 15 days from the date of purchase. If you need to perform a refund or replacement product, but its packaging is damaged or absent, the buyer shall reimburse the cost. Thank you for your understanding!

Name	Information on warranty maintenance	Period
The unit	Component parts of the main unit (not including cup)	1 year
Accessories	Power cord, bowl	1 year

II Warranty period

The warranty period is calculated from the date of receipt of the goods by the buyer or its installation;

If you can not tell the date of receipt of the goods or their installation, the warranty period is calculated from the date shown on the sales receipt;

If you can not provide documentary evidence of a valid warranty card, warranty service is valid for 6 months from the date of manufacture the device;

If you can not provide documentary evidence of a valid warranty card and can not see the production date, in this case, the warranty is valid for 6 months from the date of the earliest appearance of the product on the market.

III Documentary proof of a valid warranty card

To confirm the applicable warranty after-sales service you can provide a signed receipt for the goods, receipt and warranty card.

IV Measuring cup, spoon (flat surface), spoon (soup) are not included in the warranty service

V Terms that are not included in the warranty service

1. Damage or breakage caused by the fault of the consumer, resulting from transportation, improper storage or use;
2. Making the device, its maintenance by unauthorized representatives of other companies, causing any damage (including, if the user to repair or disassemble the machine);
3. No warranty card, purchase receipt or other proof of purchase;
4. The presence of patches, the mismatch of the sales receipt or the warranty card with the goods;
5. Damage caused by force majeure;
6. The warranty period has expired;
7. The emergence of problems as a result of use of the product in improper surroundings, which does not match the description in the manual (eg, voltage, ventilation, etc.).

If you have any questions, go to the site after-sales service or call technical support.

Producer: «Shanghai Chunmi Electronic Technology»

Location: China (Shanghai), district. Ziyou Maoyi Shiyan, ul. Shengxia 399, avenue k.1, zd.328, k.3075

Standard: GB 4706.1-2005 GB 4706.19-2008 GB 4706.14-2008 GB 9684-2011 Q31 / 0115000393C001-2015

This product has additional elements made from a plastic material that has been manufactured and provided by company «Foshan Maijinyi Siliao» Ltd.

Located on the production license: Guandun XK16-204-01896

XIAOMI-MI.COM